



TRUSSLITE™

QUICK, INNOVATIVE & VERSATILE

TRUSSLITE TL24

# QUICKLOCK LINE

# TL24 box

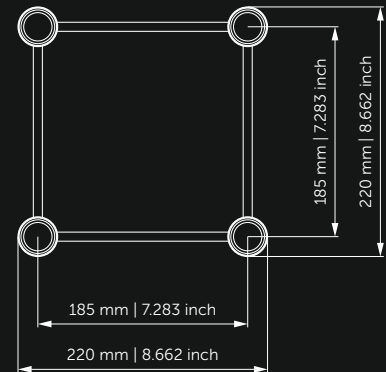
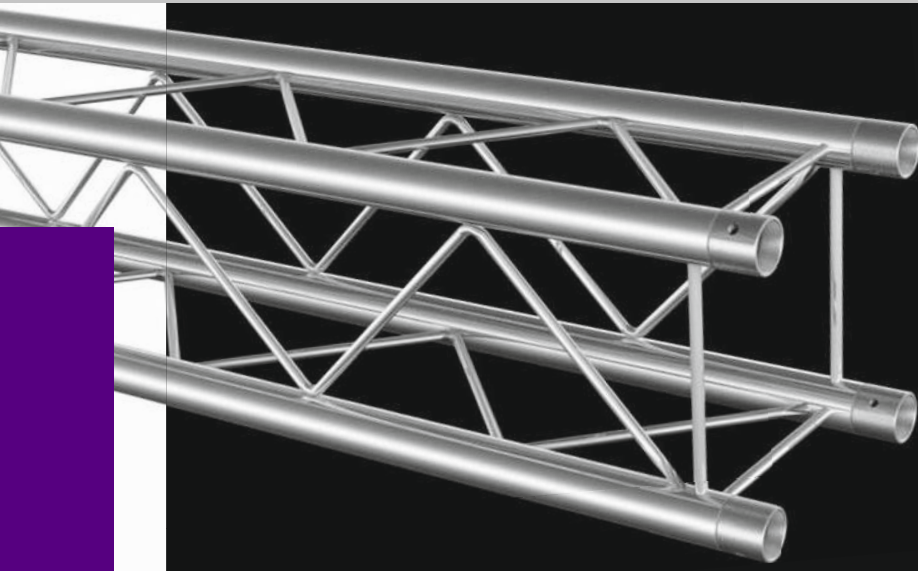

## SPECIFICATIONS

TUBES	35x2 (1.4 x 0.08inch)
BRACES	8mm (0.3inch)
ALLOY	EN-AW 6082 T6

## STRAIGHT SEGMENT LENGTHS

CODE	LENGTH		WEIGHT		DESCRIPTION
TL24-50	0.5m	1.64ft	1.6kg	3.53lbs	straight segment
TL24-100	1m	3.28ft	2.8kg	6.17lbs	straight segment
TL24-150	1.5m	4.92ft	4kg	8.82lbs	straight segment
TL24-200	2m	6.56ft	5.2kg	11.46lbs	straight segment
TL24-250	2.5m	8.20ft	6.4kg	14.11lbs	straight segment
TL24-300	3m	9.84ft	7.6kg	16.76lbs	straight segment
TL24-350	3.5m	11.48ft	8.8kg	19.40lbs	straight segment
TL24-400	4m	13.12ft	10kg	22.05lbs	straight segment





## LOADING TABLES

	2m	4m	6m	8m	10m
Distrib. Load [kg/m]	264	130	87.4	62.4	49.6
Deflection [mm]	1.8	16.3	33	72	141.4
Point load [kg]	600	530	400	320	250
Deflection [mm]	3.2	15.7	42	72.2	112.7
	<b>6.56ft</b>	<b>13.12ft</b>	<b>19.68ft</b>	<b>26.24ft</b>	<b>32.81ft</b>
Distrib. Load [lb/ft]	177.4	87.4	58.7	41.9	33.3
Deflection [inch]	0.1	0.6	1.3	2.8	5.6
Point load [lb]	1322.8	1168.4	881.8	705.5	551.2
Deflection [inch]	0.1	0.6	1.7	2.8	4.4

**CORNERS**





**TL24-C19**

 1m (3.28ft)  
 2-way 45° corner  
 3.5kg (7.72lbs)





**TL24-C20**

 1m (3.28ft)  
 2-way 60° corner  
 2.3kg (5.07lbs)



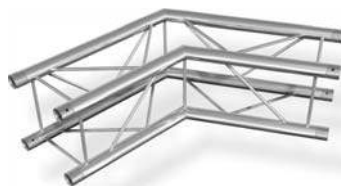

**TL24-C21**

 0.5m (1.64ft)  
 2-way 90° corner  
 2.1kg (4.63lbs)



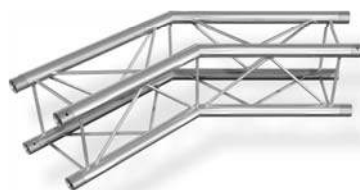

**TL24-C22**

 0.5m (1.64ft)  
 2-way 120° corner  
 2.4kg (5.29lbs)



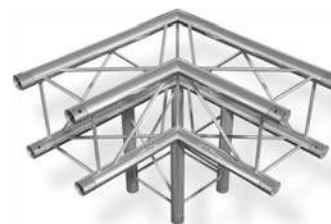

**TL24-C23**

 0.5m (1.64ft)  
 2-way 135° corner  
 2.5kg (5.51lbs)





**TL24-C30**

 0.5m (1.64ft)  
 3-way 90° corner  
 2.7kg (5.95lbs)





**TL24-T35**

 0.5m (1.64ft)  
 3-way T-junction  
 2.7kg (5.95lbs)





**TL24-C41**

 0.5m (1.64ft)  
 4-way cross junction  
 3.5kg (7.72lbs)





**TL24-T42**

 0.5m (1.64ft)  
 4-way 90° corner  
 3.5kg (7.72lbs)





**TL24-C55**

 0.5m (1.64ft)  
 5-way T-junction  
 4.3kg (9.48lbs)

**CIRCLES**



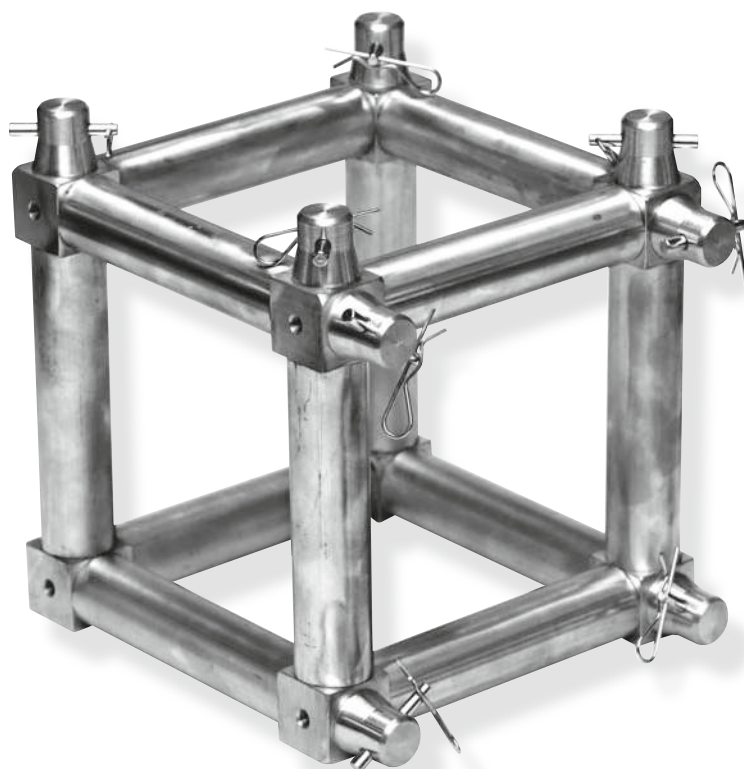

**TL24-C**

 Circle  
various diameters



**TL24-MCB**

 0.22m (0.72ft)  
 Universal junction box  
 3.5kg (7.7lbs)

Includes 2 connection sets for two ways.