



TRUSSLITE™

QUICK, INNOVATIVE & VERSATILE

TRUSSLITE TL44

QUICKLOCK LINE

TL44 box

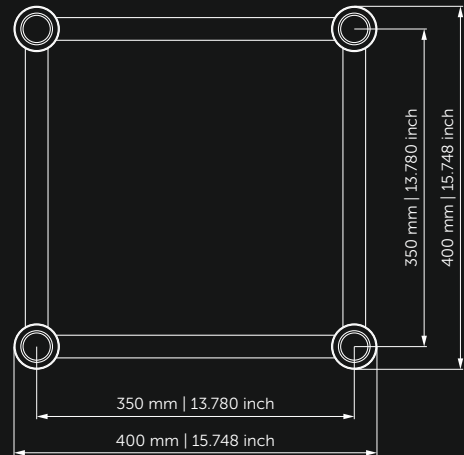
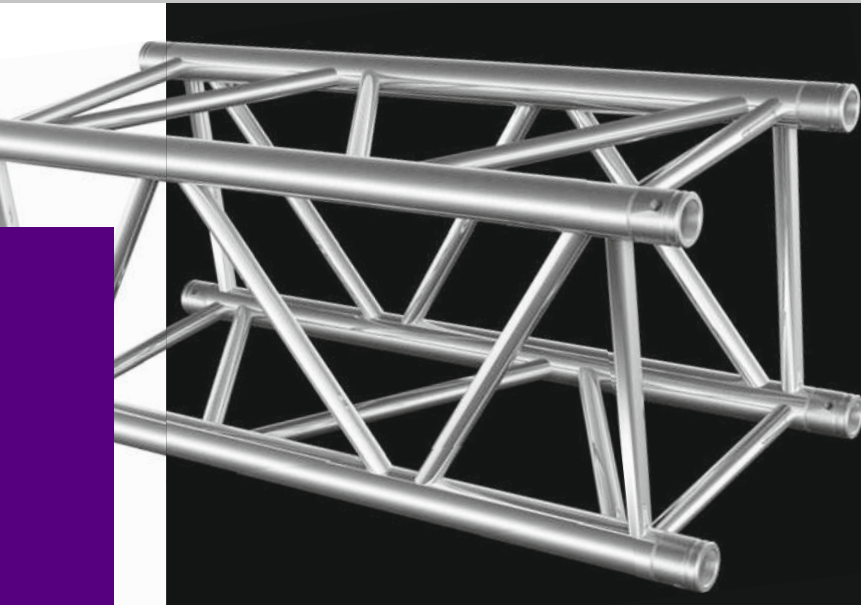

SPECIFICATIONS

TUBES	50x2mm (2 x 0.08inch)
BRACES	25x3mm (1 x 0.12inch)
ALLOY	EN-AW 6082 T6

STRAIGHT SEGMENT LENGTHS

CODE	LENGTH		WEIGHT		DESCRIPTION
TL44-50	0.5m	1.64ft	6kg	13.23lbs	straight segment
TL44-100	1m	3.28ft	9.2kg	20.28lbs	straight segment
TL44-150	1.5m	4.92ft	10.8kg	23.81lbs	straight segment
TL44-200	2m	6.56ft	13.4kg	29.54lbs	straight segment
TL44-250	2.5m	8.20ft	15.6kg	34.39lbs	straight segment
TL44-300	3m	9.84ft	18.1kg	39.90lbs	straight segment
TL44-350	3.5m	11.48ft	21kg	46.30lbs	straight segment
TL44-400	4m	13.12ft	23.3kg	51.37lbs	straight segment
TL44-450	4.5m	14.76ft	25.7kg	56.66lbs	straight segment
TL44-500	5m	16.40ft	28.3kg	62.39lbs	straight segment





LOADING TABLES

	2m	4m	6m	8m	10m	12m	14m	16m
Distrib. Load [kg/m]	1000	630	300	164	104	68	48	36
Deflection [mm]	2.3	11.7	23.2	39.6	61.6	85.5	115.3	152.8
Point load [kg]	2000	1300	880	660	500	420	340	280
Deflection [mm]	3.2	9.2	18.9	32.8	48.9	72.4	96.4	124.6
	6.56ft	13.12ft	19.68ft	26.24ft	32.81ft	37.37ft	45.93ft	52.49ft
Distrib. Load [lb/ft]	671.9	423.3	201.6	110.2	69.9	45.9	32.3	53.6
Deflection [inch]	0.1	0.46	1	1.6	2.4	3.4	4.5	6
Point load [lb]	4409	2866	1940	1455	1102	925.9	749.6	617
Deflection [inch]	0.1	0.4	0.7	1.3	1.9	2.8	3.8	4.9

CORNERS



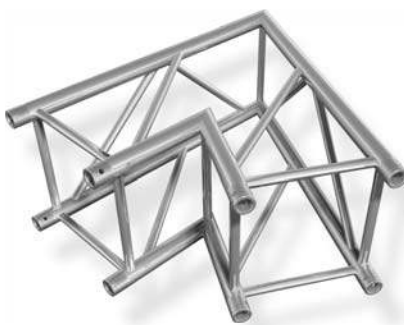

TL44-C19

 1.5m (4.92ft)
 2-way 45° corner
 11.9kg (26.24lbs)





TL44-C20

 1m (3.28ft)
 2-way 60° corner
 10kg (22.05lbs)



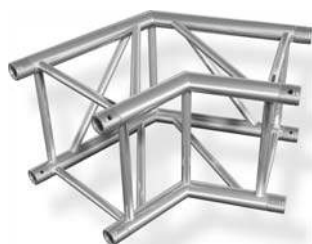

TL44-C21

 0.5m (1.64ft)
 2-way 90° corner
 7.2kg (15.87lbs)



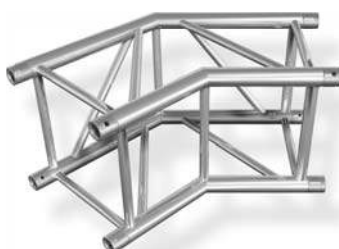

TL44-C22

 0.5m (1.64ft)
 2-way 120° corner
 7.4kg (16.31lbs)



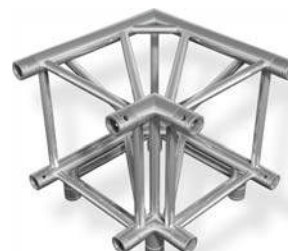

TL44-C23

 0.5m (1.64ft)
 2-way 135° corner
 7.5kg (16.53lbs)





TL44-C30

 0.5m (1.64ft)
 3-way 90° corner
 9.8kg (21.61lbs)





TL44-T35

 0.6x0.5m (1.97x1.64ft)
 3-way T-junction
 8.8kg (19.40lbs)





TL44-C41

 0.6m (1.97ft)
 4-way cross junction
 9.6kg (21.16lbs)



TL44-T42

 0.6x0.5x0.5m (1.97x1.64x1.64ft)
 4-way T-junction
 11.2kg (24.69lbs)



TL44-T51



0.6x0.6x0.5m
(1.97x1.97x1.64ft)
5-way junction
12.2kg (26.90lbs)



TL44-MCB



0.4m (1.31ft)
Multi connection box
8kg (17.64lbs)

CIRCLES



TL44-C



Circle
various diameters